

User Manual

DuraPanel Series

DuraPanel 7"

DuraPanel 12"



Disclaimer

ISIC A/S makes no representation or warranties with respect to the contents or use of this manual, and specifically disclaims any express or implied warranties of merchantability or fitness for any particular purpose. Further, ISIC A/S reserves the right to revise this publication and to make changes to its content at any time, without obligation to notify any person or entity of such revisions or changes.

Image sticking: If the monitor is operated with static images (logo's etc) it will inevitably lead to images sticking on the display (like on old CRT's). This is not a permanently situation and can be removed by operating the monitor with a completely black screen.

FCC Warning

Computing devices and peripherals generate and radiate radio frequency energy, and if not installed and used in accordance with the instructions advised by ISIC A/S, it may cause interference to radio communication.

The DuraPanel series, manufactured by ISIC A/S, is designed to comply with the emerging generic EEC standards, that cover applications in maritime environment.

Classification

The monitor is classified as "protected from the weather" according to IEC 60945 ed.4 (former class b).

Approvals

Approval according to IACS E10 ed. 6 and IEC 60945 ed. 4, Maritime navigation and radio communication equipment and systems – General requirements.



ISIC A/S is complying with the WEEE directive within the European Union, stating that electronic and electric products must be collected separately. Products are marked according to the directive.

Copyright 2015 ISIC A/S
ISIC PN: 07353-000 rev. A

ISIC A/S
Edwin Rahrsvej 54
DK-8220 Brabrand
Denmark

Phone: +45 70 20 70 77
Fax: +45 70 20 79 76
Web: <http://www.isic-systems.com>

Table of Contents

1	FEATURES	4
2	GENERAL CONSIDERATIONS ON INSTALLATION AND OPERATION	4
3	DURAPANEL CONNECTIONS	5
4	CONNECTOR PIN-OUT	6
5	TECHNICAL SPECIFICATION DURAPANEL 7"	7
6	TECHNICAL SPECIFICATION DURAPANEL 12"	8
7	MECHANICAL OUTLINE DURAPANEL 7" – DROP IN	9
8	MECHANICAL OUTLINE DURAPANEL 7" – FLUSH MOUNT	10
9	MECHANICAL OUTLINE DURAPANEL 7" – RETROFIT	11
10	MECHANICAL OUTLINE DURAPANEL 7" – SIMULATOR	12
11	MECHANICAL OUTLINE DURAPANEL 7" – OPTIONAL FAN	13
12	MECHANICAL OUTLINE DURAPANEL 12" - FLUSH	14
13	MECHANICAL OUTLINE DURAPANEL 12" - RETROFIT	15
14	DURA COMMUNICATION PROTOCOL	16
15	COMPASS SAFE DISTANCE	21
16	POWER CONSUMPTION	21
17	IN RUSH CURRENT	21
18	TROUBLESHOOTING.....	21
19	SERVICING THE UNIT	21
20	ISIC INFO / SUPPORT.....	22
21	REVISION HISTORY	23
22	APPENDIX A: PIXEL POLICY.....	24
23	APPENDIX B: CERTIFICATE OF CONFORMITY.....	27

1 Features

Congratulations on your purchase of a DuraPanel. This short form manual is designed to get you started working with your new DuraPanel.

The DuraPanel series of Panel Computers are all designed for the demanding operating conditions at sea.

The DuraPanel series are tested for full compliance to marine-standards IACS E10 and IEC 60945.

The DuraPanel comes with excellent brightness and contrast levels that, together with wide viewing angles, ensure a good readability thus making it very eye-friendly. For the best picture quality, always use a double shielded DVI or VGA cable with ferrites, like the one supplied with the unit.

2 General considerations on Installation and Operation

The DuraPanel is designed to work at conditions according to IEC 60945. However, keeping the temperature and vibration level at a minimum will extend the life time of the product. ISIC recommend operating this product at normal room temperature (20-25 °C), with the lowest level of vibration and humidity.

Installation of the DuraPanel

In order to obtain the best possible operating conditions, please note the following precautions.

- Room for cooling.
When designing the cabinet/console for the DuraPanel, please ensure that air can flow freely around the cabinet, in order to avoid any unnecessary rise in temperature. If it is not possible to have an adequate natural airflow, use a fan to force the airflow to be higher.
- Mounting positions
The DuraPanel is designed for both horizontal and vertical installation.
- Sunlight
Avoid direct sunlight to keep temperature low by that improve lifetime.

3 DuraPanel connections

Below is a view of connections to the DuraPanel.

3.1 DuraPANEL 7" connections

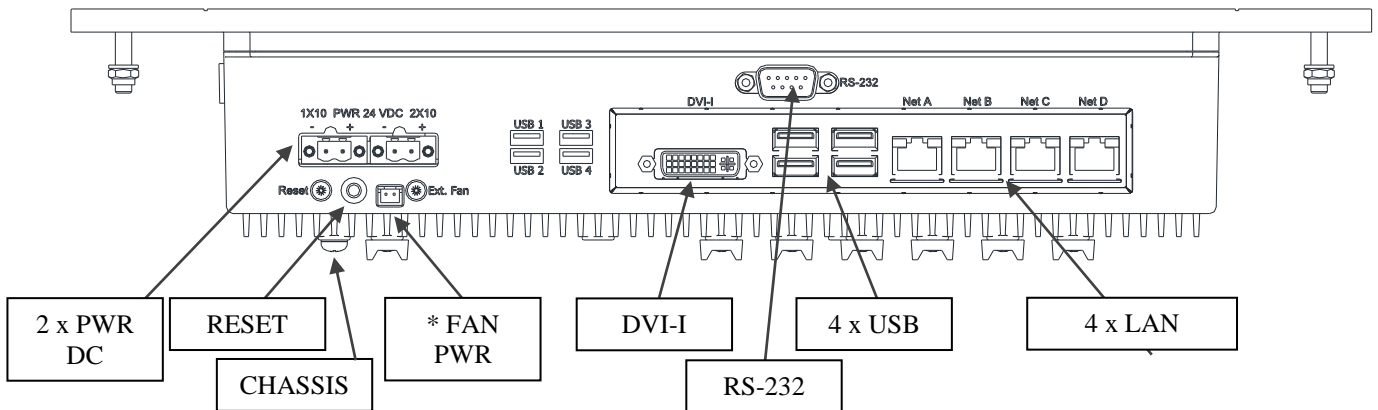

3.2 DuraPANEL12" connections

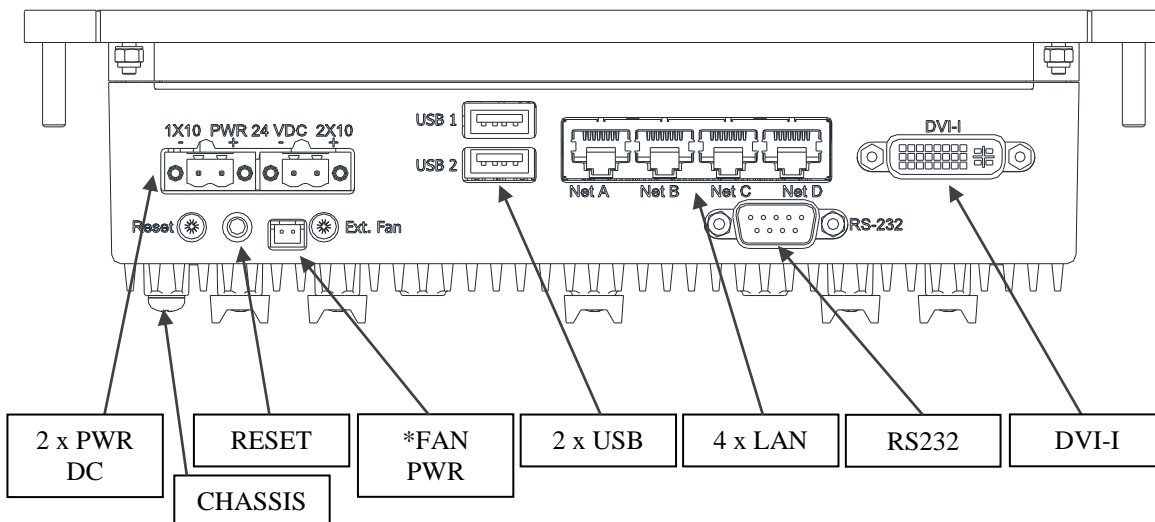

* Optional fan output.

4 Connector pin-out

4.1 RS-232

Product	COM port used for external communication
DuraPanel7"	COM2
DuraPanel12"	COM1

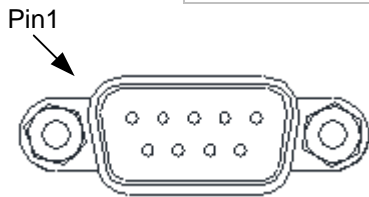

Pin	RS-232
	SUB-D 9-pol male
1	-
2	Monitor TX
3	Monitor RX
4	-
5	GND
6	-
7	-
8	-
9	-

Mating part: SUB-D 9 pole female, Norcomp 172-E09-20201 or equivalent.

4.2 Power input

The nominal input power voltage is 24V (18-36VDC). There are two independent galvanic isolated power inputs.

Mating part number: Weidmüller BLZP5.08HC/02/180F

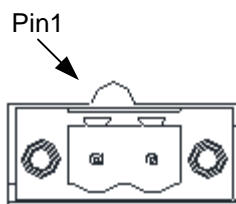

Pin	Power in
1	0VDC
2	24VDC

4.3 Fan output

Mating part: JST XHP-2 (housing), SXH-001T-P0.6 (terminal)

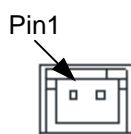

Pin	FAN out
1	12VDC
2	0VDC

5 Technical specification DuraPanel 7"

DuraPANEL - General

CPU:	Intel® Celeron® Processor J1900, 2.42 GHz (4 Cores / 4 Threads)
Chipset:	Intel® processor Core, Graphics and Memory Controller in a single system-on-chip (SOC) solution
Memory:	1 x SODIMM sockets with 1x 4GB DDR3L 1600MHz mounted <i>Up to 8GB DDR3L SODIMM</i>
Hard Disk Drive:	80GB Intel® S3500 SSD SATA <i>Optional sizes 120GB / 160GB / 240GB / 300GB ... 800GB SSD SATA III</i>
Video:	Intel® HD Graphics controller on-CPU <i>DirectX* 11 and OpenGL 4.0 compliant Dual Independent display capable</i>
External Video out:	1 x DVI-I video output connector
Audio:	Built-in Buzzer (75-85 dB(A) / 1m)
Ethernet:	4 x 10/100/1000 Mbps/s Ethernet LAN on-board, (RJ45) with auto-negotiate <i>2 x Intel and 2 x Realtek</i>
USB:	2 x USB 2.0 (max 0,5 Amp per USB, max 5 Watt total)
COM:	1 x RS232/422/485 (configurable)
OS:	Windows 7, Windows 8, Linux

DuraPANEL - Front

Display size:	7 inch LCD (TFT), IPS technology
Resolution:	800 x 480
Active area:	152 x 91 mm
View angle:	89° (T/B), 89° (L/R) (typical)
Luminance:	450 Cd/m ² (typical) <i>Optional Ambient light sensor</i>
Contrast ratio:	800:1 (typical)
Touch:	10 finger PCAP touch (internal USB interface)
Front glass:	Anti Reflection
Protection:	IP56 (from front, when mounted) IP22 (from rear)

DuraPANEL - Power

Standard:	18-34VDC Galvanic isolated <i>Optional Dual input DC power, Galvanic isolated</i>
Power Consumption:	P _{typ} = 10 Watt, P _{max} = 15 Watt

DuraPANEL - Environmental

Operating Temperature:	-15 to +55 °C
Storage Temperature:	-25 to +70 °C
Relative Humidity:	8 to 95 % (non-condensing)

DuraPANEL - Approvals

CE Mark:	EN61000-6-2
Marine:	IACS E10 Rev. 5 & IEC 60945 Ed. 4
Shock:	±5G, 10ms in accordance with IEC 60068-2-27
Certificates:	MR certificate

DuraPANEL - Dimensions

Size:	218 (W) x 147mm (H) x 59mm (Depth behind bezel)
Weight:	App. 2 kg.
Optional Bracket:	Desk/ceiling-and wall-bracket (VESA 75x75mm)
Optional Accessories:	External fan for VESA mounting

6 Technical specification DuraPanel 12"

DuraPANEL - General

CPU:	Intel® Celeron® Processor 2980U (2M Cache, 1.60 GHz) (2 Cores / 2 Threads)
Chipset:	Intel® processor Core, Graphics and Memory Controller in a single system-on-chip (SOC) solution
Memory:	2 x SODIMM sockets with 1x 4GB DDR3L 1600MHz mounted <i>Up to 16GB DDR3L SODIMM</i>
Primary Disk Drive:	80GB Intel® S3500 SSD SATA <i>Optional sizes 120GB / 160GB / 240GB / 300GB ... 800GB SSD SATA</i>
Optional Secondary Disk Drive (Removable):	80GB Intel® S3500 SSD SATA (optional) <i>Optional sizes 120GB / 160GB / 240GB / 300GB ... 800GB SSD SATA</i>
Video:	Intel® HD Graphics controller on-CPU <i>DirectX® 11 and OpenGL 4.0 compliant Dual Independent display capable</i>
External Video out:	1 x DVI-I video output connector
Audio:	Built-in Buzzer (75-85 dB(A) / 1m)
Ethernet:	4 x 10/100/1000 Mbits/s Ethernet LAN on-board, (RJ45) with auto-negotiate <i>1 x Intel® I218 and 3 x Intel® I210AT</i>
USB:	4 x USB 3.0 (max 0,5 Amp per USB, max 5 Watt total)
COM:	1 x RS232/422/485 (configurable)
OS:	Windows 7, Windows 8, Linux

DuraPANEL - Front

Display size:	12,1 inch 16:10 LCD (TFT), MVA technology
Resolution:	1280 x 800
Active area:	261 x 163 mm
View angle:	88° (T/B), 88° (L/R) (typical)
Luminance:	400 Cd/m ² (typical) <i>Optional Ambient light sensor</i>
Contrast ratio:	1000:1 (typical)
Touch:	10 finger PCAP touch (internal USB interface)
Front glass:	Anti Reflection
Protection:	IP56 (from front, when mounted) IP22 (from rear)

DuraPANEL - Power

Standard:	18-34VDC Galvanic isolated <i>Optional Dual input DC power, Galvanic isolated</i>
Power Consumption:	P _{typ} = 20 Watt, P _{max} = 25 Watt

DuraPANEL - Environmental

Operating Temperature:	-15 to +55 °C
Storage Temperature:	-25 to +70 °C
Relative Humidity:	8 to 95 % (non-condensing)

DuraPANEL - Approvals

CE Mark:	EN61000-6-2
Marine:	IACS E10 Rev. 5 & IEC 60945 Ed. 4
Shock:	±5G, 10ms in accordance with IEC 60068-2-27
Certificates:	MR certificate

DuraPANEL - Dimensions

Size:	396 mm (W) x 256 mm (H) x 63.5 mm (Depth behind bezel) – Drop-in retrofit 13.3" version
Weight:	App. 4 kg.
Optional Bracket:	Desk/ceiling-and wall-bracket (VESA 75x75mm)

7 Mechanical outline DuraPanel 7" – Drop in

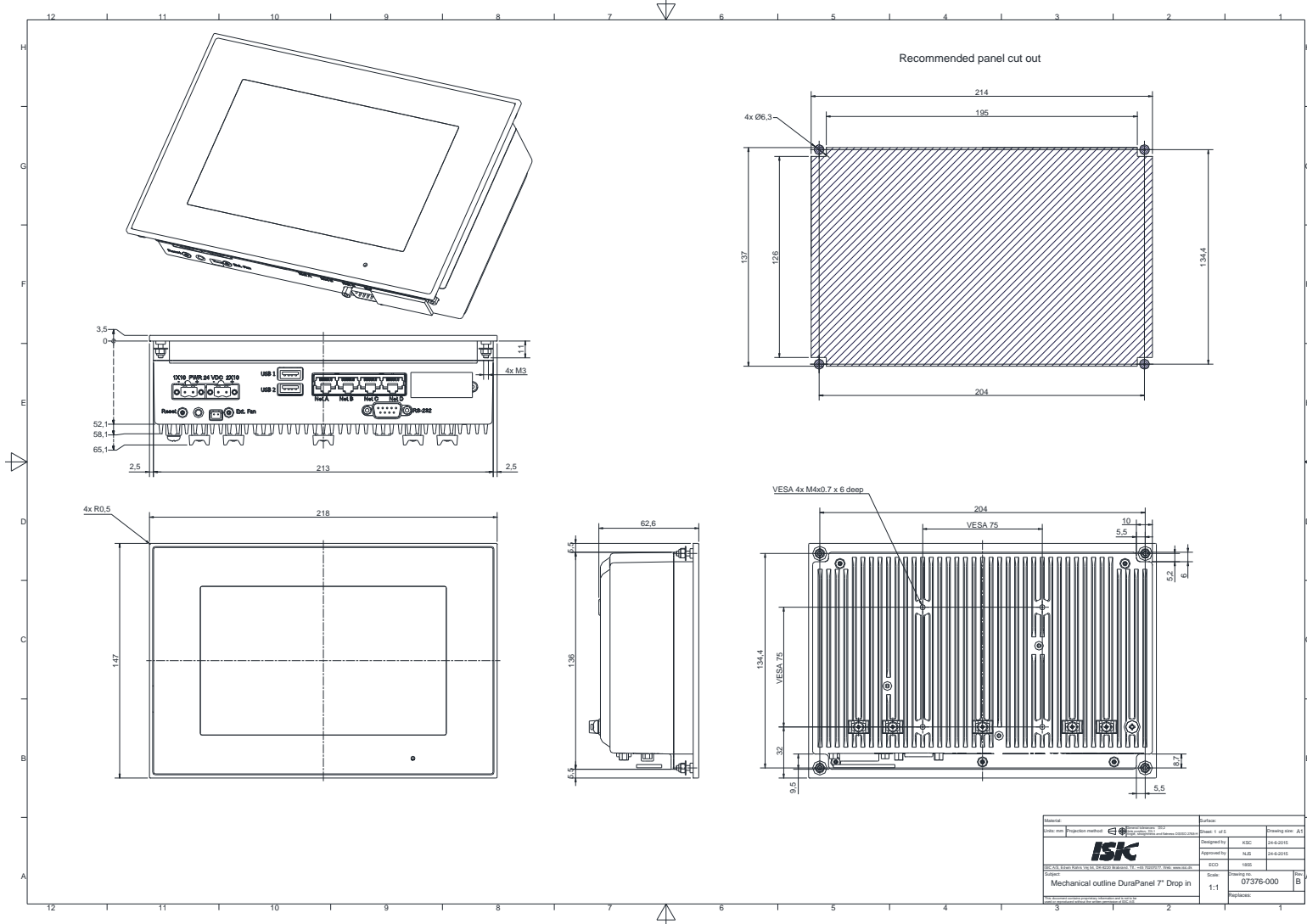

 ISK Mechanical outline DuraPanel 7" Drop in	Edition: 1 of 5 Designed by: KSC Approved by: NLS Date: 24-03-15 Title: 07376-000 Scale: 1:1 Replaces:	Drawing title: AT Date: 24-03-15 Date: 24-03-15
---	--	---

8 Mechanical outline DuraPanel 7" – Flush mount

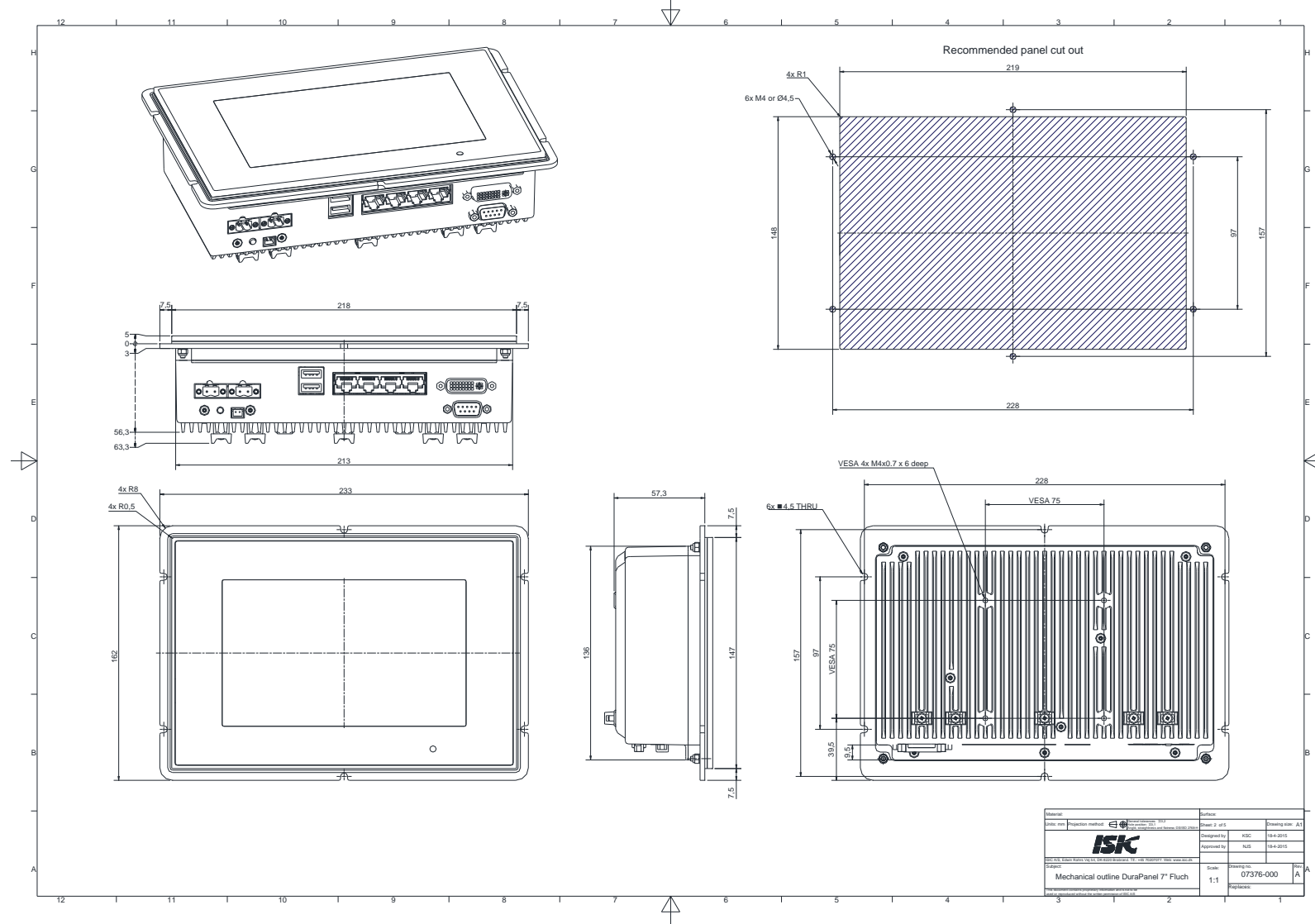

10 Mechanical outline DuraPanel 7" – Simulator

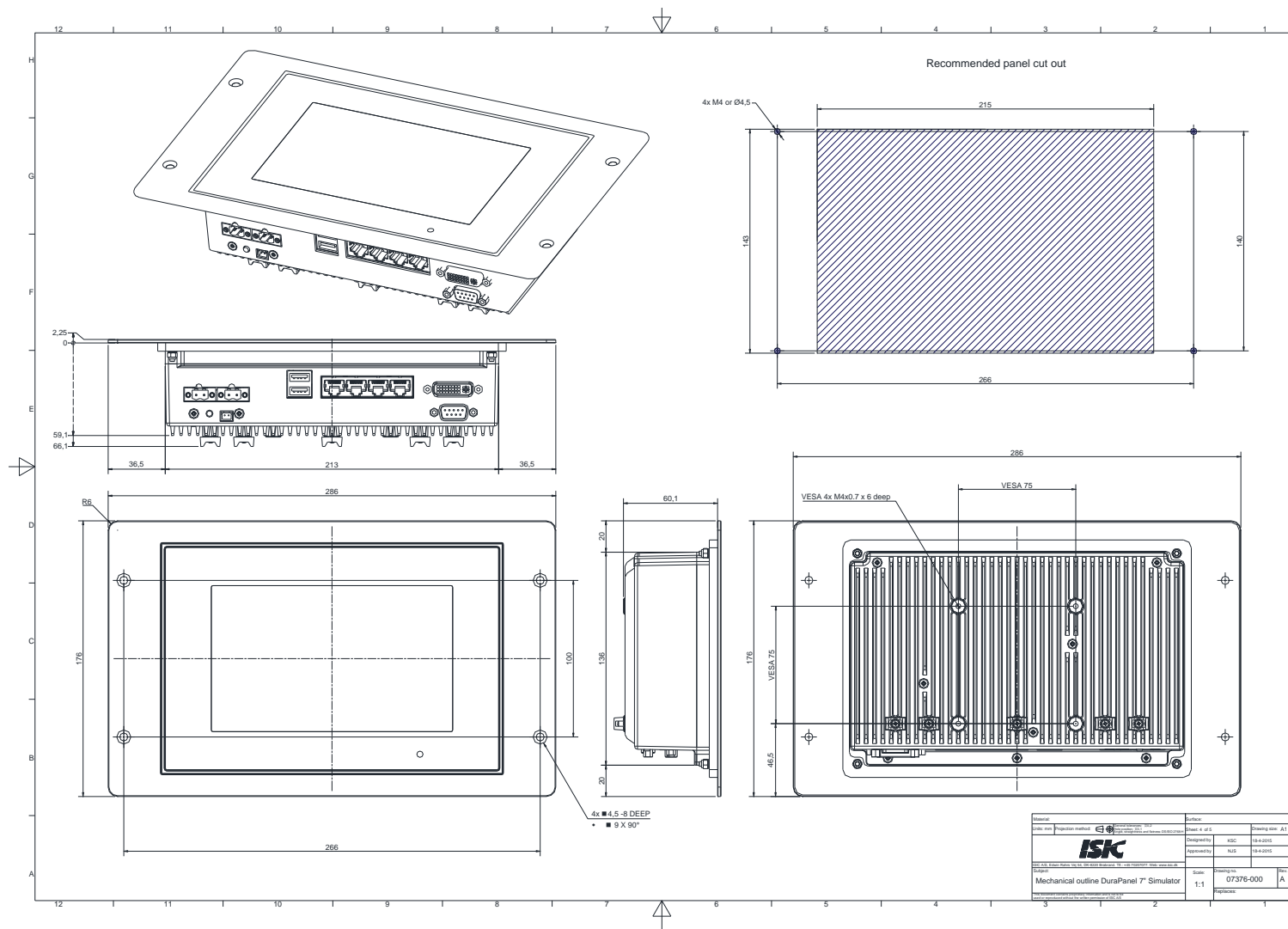

11 Mechanical outline DuraPanel 7" – Optional fan

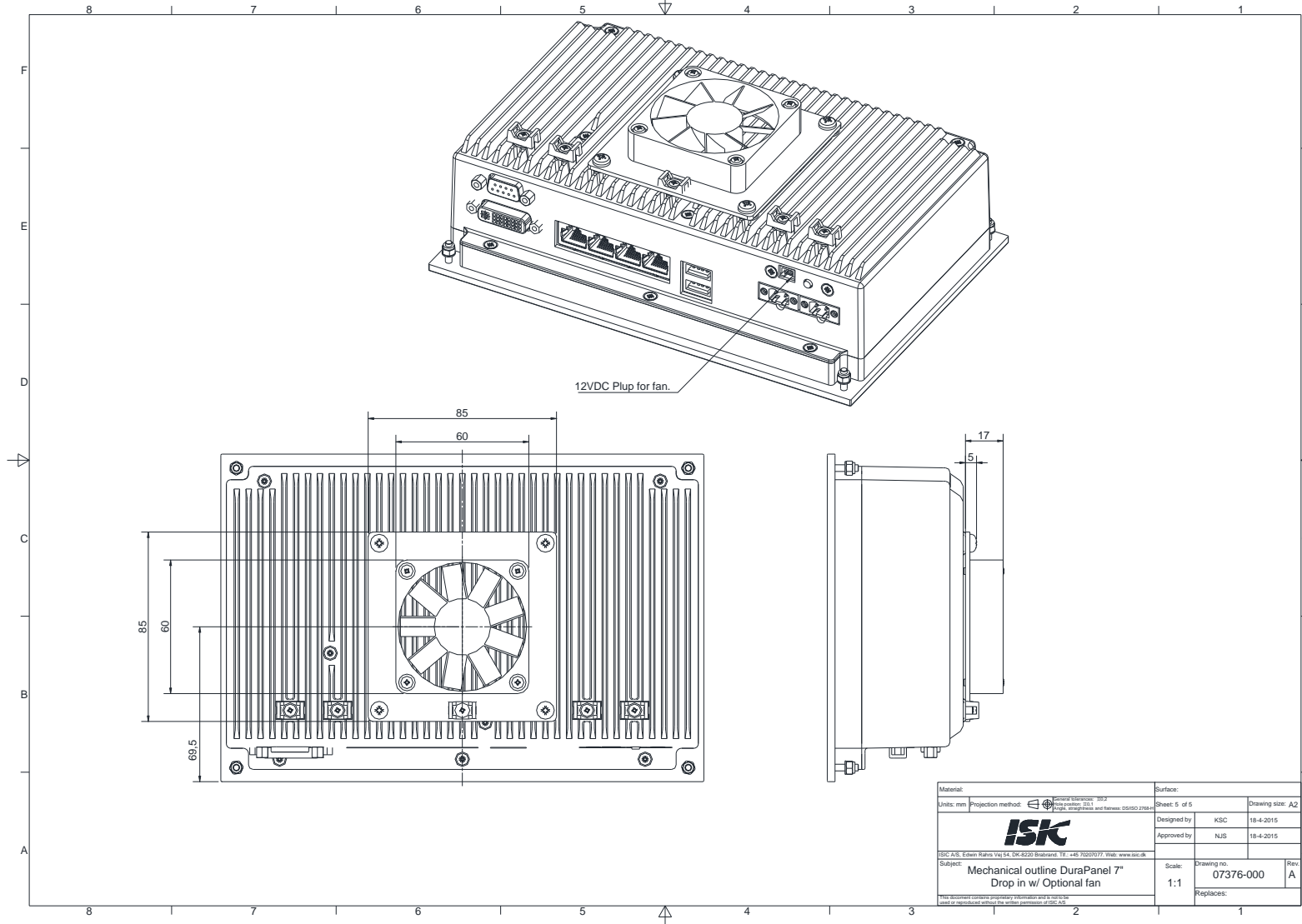

Material:		Surface:	
Units: mm	Projection method:	Sheet: 5 of 5	Drawing size: A2
		Designed by:	KJSC 18-4-2015
		Approved by:	NJS 18-4-2015
<small>ISK A/S, Egevej 14, DK-5220 Brønderslev, Tlf. +45 70207077, Web: www.isk.dk</small>		Scale:	Drawing no.
Subject: Mechanical outline DuraPanel 7" Drop in w/ Optional fan		1:1	07376-000
		Replaces:	
		Rev: A	

12 Mechanical outline DuraPanel 12" - Flush

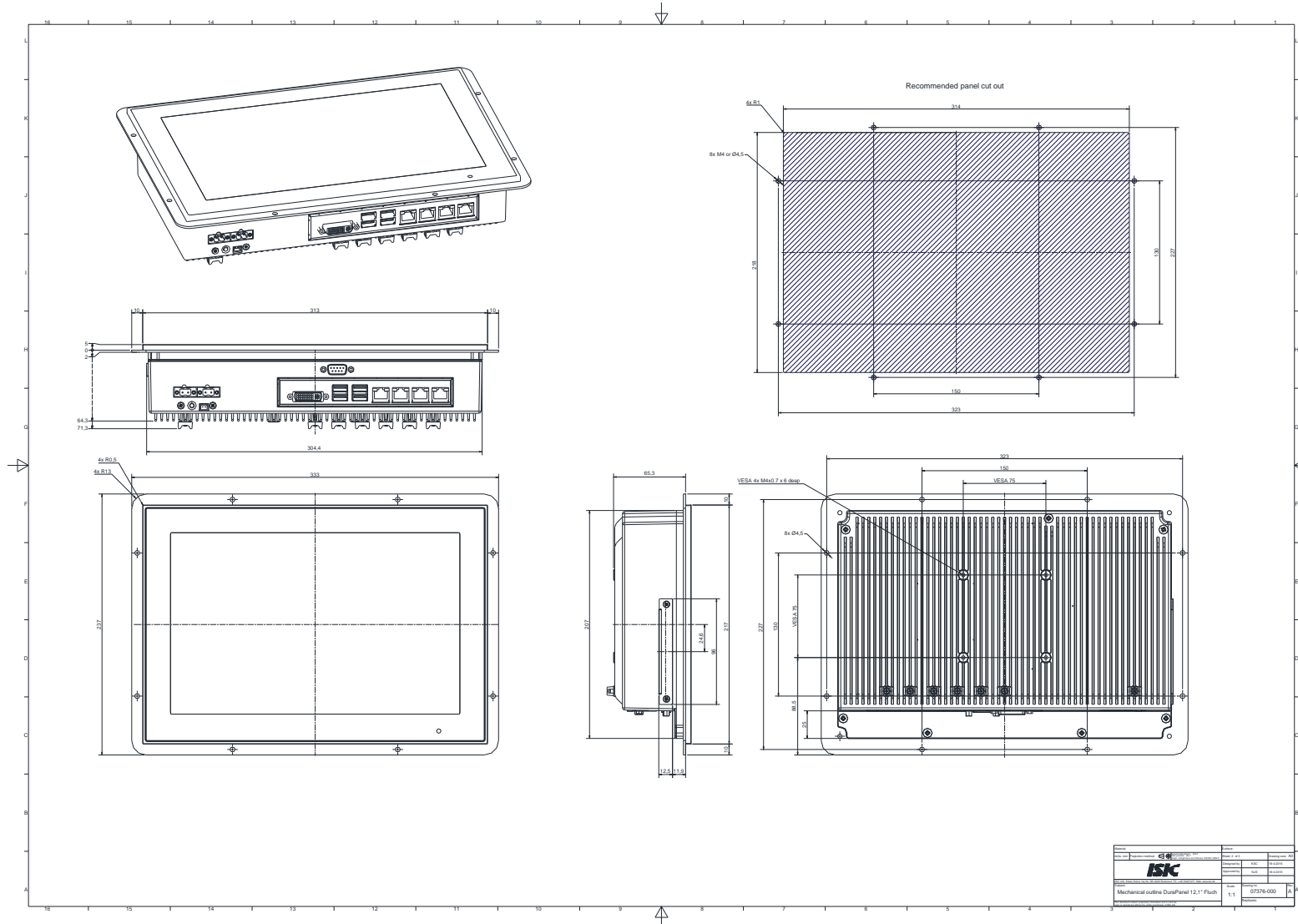

13 Mechanical outline DuraPanel 12" - Retrofit

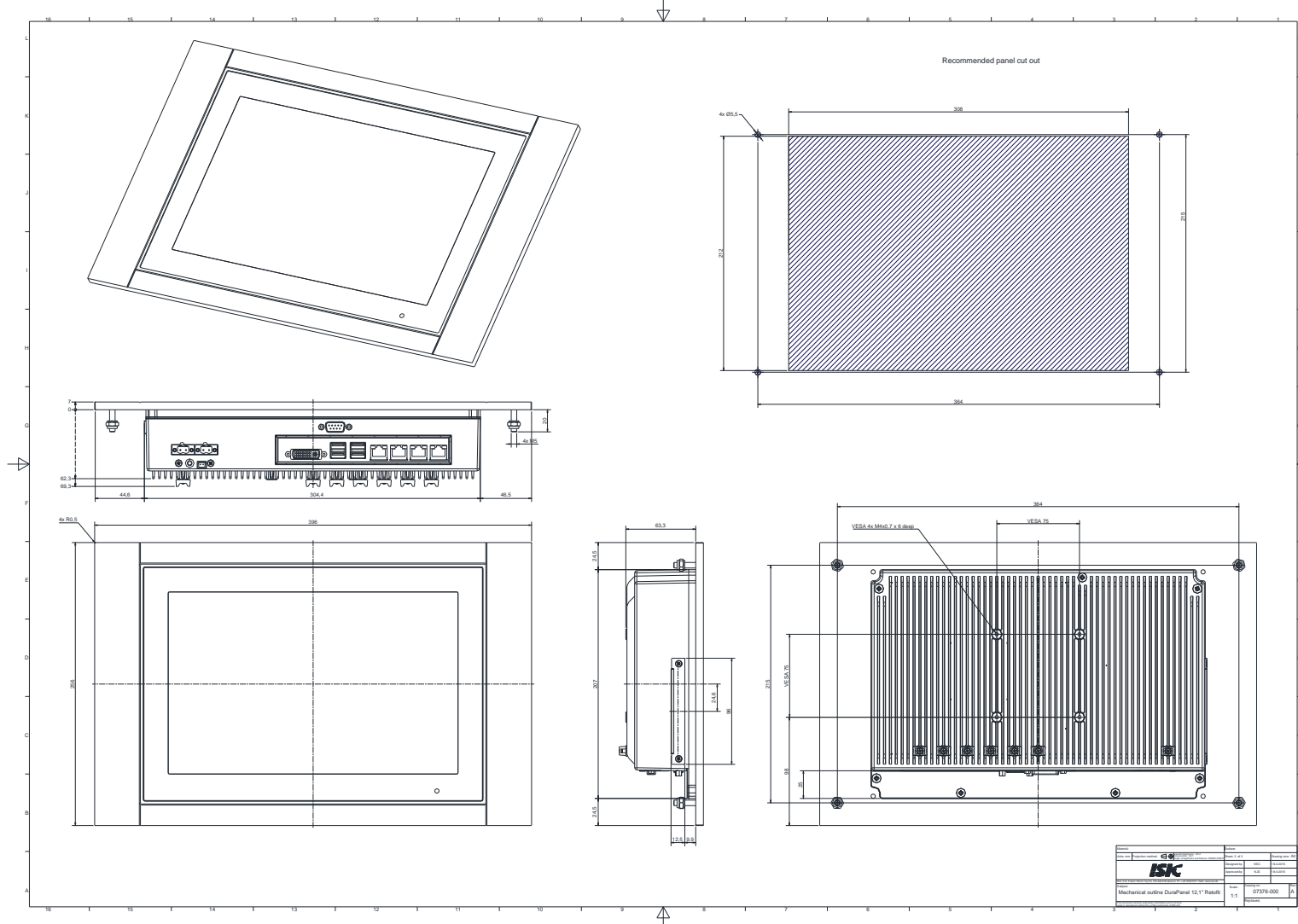

14 Dura Communication protocol

14.1 Message Format

The interface board supports a data rate of 19200 bits per second. Data shall be transmitted with no parity, one start bit, and one stop bit. The basic message format is shown below:



The minimum message length is 7 bytes.

14.1.1 Attention (ATTN)

This byte identifies the start of a message. The following three values are defined:

ATTN	Description
0x07	Command
0x06	Acknowledge
0x15	Negative Acknowledge

A remote master initiates a command using the 0x07 attention code. The interface board will reply with an acknowledge (ACK) code if the command was received successfully, or a negative acknowledge (NACK) if the command contained errors.

Note that the interface board will acknowledge messages, even if it fails to execute the actions contained within. NACKs are only issued when the message format is corrupted, e.g. invalid checksums.

14.1.2 Address (ADDR)

This byte is used to identify and address individual interface boards. In a multi-slave configuration, the master can target each interface board individually, in which case the addressed interface board will reply with either an ACK or a NACK.

The remote master can address all interface boards simultaneously using the broadcast address. In this case the interface boards will not reply.

ADDR	Description
0x00:0xFE	Individual address space
0xFF	Broadcast address

14.2 Command (CMD)

The following commands are defined for the interface board:

CMD	Description
MAN	Manufacturer ID
BZZ	Buzzer Control Command
FAN	Fan Control Command
ETC	Elapsed Time Counter
TMP	Temperature Sensor
LIS	Light Sensor

14.2.1 Data Length (LEN)

This byte contains the length of the DATA field. The minimum value is 0 bytes. No messages have been defined with a length of more than 35 bytes.

14.2.2 Inverse Header Checksum (IHCHK)

This is a simple 8 bit checksum. The checksum byte is initialized to 0. A bit-wise inversion of bytes 0 to 5 is performed. The 8 bit sum (without carry) of inverted bytes 0 to 5 and byte 6 shall be 0xFF.

If a message fails the checksum, the interface board will reply with a NACK message with zero data. This requirement does not apply to broadcasted messages.

14.2.3 Data Sent (DS)

The DS field is only transmitted as a mirror of the sent data.

14.2.4 Data Field (DATA)

The data field is only transmitted if LEN is greater than 0. The field carries additional data depending of the message command.

14.2.5 Inverse Data Checksum (IDCHK)

The inverse data checksum is only transmitted if LEN is greater than zero. The checksum is initialized to 0. A bit-wise inversion of DATA field(s) is performed. The 8 bit sum (without carry) of the inverted bytes and the IDCHK shall be 0xFF.

The interface board will reply with a NACK to all messages with invalid checksums. This requirement does not apply to broadcasted messages.

14.2.6 No Operation (NOP)

This is empty data '0x00' and only used as a filler between detection bytes for the reset command.

14.3 Message Command

14.3.1 Manufacturer ID (MAN)

This command shall be sent to the interface board to request Manufacturer ID Code. No data shall be sent with the command

The interface board will reply to this command with an ACK attention code. The DATA field will be set to an ASCII string with the value "ISIC".

Example:

Ask for the Manufacturer ID:

ATTN	ADDR	CMD			LEN	IHCHK
0x07	0x00	0x4D	0x41	0x4E	0x00	0x1C

Reply from interface board ("ISIC"):

ATTN	ADDR	CMD			LEN	IHCHK	DATA				IDCHK
0x06	0x00	0x4D	0x41	0x4E	0x04	0x19	0x49	0x53	0x49	0x43	0xD7

14.3.2 Monitor Firmware Version (VER)

This command is sent to the monitor to request the Firmware Version of the embedded code. No data shall be sent with the command.

The monitor will reply to this command with an ACK attention code. The DATA field will be set to an ASCII string with the ISIC P/N and revision. Maximum length is 20 characters.

Example:

Ask for the Monitor Firmware Version:

ATTN	ADDR	CMD			LEN	IHCHK
0x07	0x00	0x56	0x45	0x52	0x00	0x0B

Reply from monitor ("07050-000-B"):

ATTN	ADDR	CMD			LEN	IHCHK	DATA					
0x06	0x00	0x56	0x45	0x52	0x0B	0x01	0x30	0x37	0x30	0x35	0x30	0x2D

DATA (cont.)					IDCHK
0x30	0x30	0x30	0x2D	0x42	0xD7

14.3.3 Buzzer Control Command (BZZ)

This command will change the state of the buzzer on interface boards with a buzzer integrated.

The value placed in the DATA field selects the state of the buzzer as listed below:

DATA	State
0x00	Turn the buzzer off (DEFAULT)
0xFF	Turn the buzzer on

If the checksum is valid and the command completes successfully, the interface board will reply with an ACK message with the current buzzer state in the DATA field.

If the checksum was invalid, the interface board will reply with an ACK message.

Example:

Turn the buzzer on:

ATTN	ADDR	CMD			LEN	IHCHK	DATA	IDCHK
0x07	0x00	0x42	0x5A	0x5A	0x01	0x01	0xFF	0x00

Reply from Interface board:

ATTN	ADDR	CMD			LEN	IHCHK	DATA	IDCHK
0x06	0x00	0x42	0x5A	0x5A	0x01	0x02	0xFF	0x00

14.3.4 Fan Control Command (FAN)

This command will change the state of the fan on monitors with a fan integrated.

The value placed in the DATA field selects the state of the fan as listed below:

DATA	State
0x00	Turn the fan off
0x01	Switches the fan to temperature controlled (DEFAULT)
0xFF	Turn the fan on

If the checksum is valid and the command completes successfully, the monitor will reply with an ACK message with the current fan state in the DATA field.

If the checksum was invalid, the monitor will reply with a NACK message.

Example:

Turn the fan on:

ATTN	ADDR	CMD			LEN	IHCHK	DATA	IDCHK
0x07	0x00	0x46	0x41	0x4E	0x01	0x22	0xFF	0x00

Reply from Monitor:

ATTN	ADDR	CMD			LEN	IHCHK	DATA	IDCHK
0x06	0x00	0x46	0x41	0x4E	0x01	0x23	0xFF	0x00

14.3.5 Temperature Sensor (TMP)

Query the interface board for the current temperature. The reply will contain a 1 byte mirror 'DS' and 3 byte ASCII string ranging from -55 to 125 °C.

Example:

Query for current temperature:

ATTN	ADDR	CMD			LEN	IHCHK	DATA	IDCHK
0x07	0x00	0x54	0x4D	0x50	0x01	0x06	0x52	0xAD

Reply from interface board ("025" for 25 °C)

ATTN	ADDR	CMD			LEN	IHCHK	DS	DATA			IDCHK
0x06	0x00	0x54	0x4D	0x50	0x04	0x04	0x52	0x30	0x32	0x35	0x16

14.3.6 Light Sensor (LIS)

Query the interface board for the surrounding light. The reply will contain a 5 byte ASCII ranging from 00000 to 65535.

Example:

Query the Light Sensor for the current value:

ATTN	ADDR	CMD			LEN	IHCHK
0x07	0x00	0x4C	0x49	0x53	0x00	0x10

Reply from interface board ("00100"):

ATTN	ADDR	CMD			LEN	IHCHK	DATA					IDCHK
0x06	0x00	0x4C	0x49	0x53	0x05	0x0C	0x30	0x30	0x31	0x30	0x30	0x0E

15 Compass safe distance

Test object / condition	Minimum Compass safe distance [cm] (5.4°/H deviation or a horizontal magnetic flux of 0.094μT)	Minimum Compass safe distance [cm] (18°/H deviation or a horizontal magnetic flux of 0.313μT)
DuraPanel 7	45 cm	30 cm
DuraPanel 12	75 cm	55 cm

16 Power Consumption

Test object / condition	P _{typ} [W]	P _{max} [W]
DuraPanel 7	10W	15W
DuraPanel 12	20W	25W

17 In rush current

Test object / condition	[A] @24VDC
DuraPanel 7	~ 85
DuraPanel 12	~ 85

18 Troubleshooting

Problem	Cause	Solutions
No picture on display	No power connected	Apply power
Touch has an offset	No grounding of the chassis	Connect ground cable to chassis screw
	No calibration of touch	Calibrate touch

19 Servicing the unit

In case that the unit still fails after following the troubleshooting send the unit to ISIC for repair via our RMA service on our web.

20 ISIC info / Support

In case you have inquiries or problems with your DuraPanel, you have a number of possibilities to get support.

Company name:	ISIC A/S
Head office:	Edwin Rahrs Vej 54 DK-8220 Brabrand Denmark
Shipping address:	Holmstrupgaardvej 5 DK-8220 Brabrand Denmark
Telephone:	+45 70 20 70 77
Fax:	+45 70 20 79 76
Mail:	mail@isic-systems.com
www:	www.isic-systems.com
VAT number:	DK 16 70 45 39
Bank Name/Address:	Handelsbanken A/S Havneholmen 29 DK-1561 København V Denmark
Bank Code:	0892
SWIFT:	HANDDKKK
IBAN for DKK:	DK53 0892 0001 0159 69
IBAN for EUR:	DK48 0892 0003 0026 19
IBAN for USD:	DK26 0892 0003 0026 27
Contacts: RFQ's:	By fax to +45 70 20 79 76 By mail to sales@isic-systems.com
Orders:	By fax to +45 70 20 79 76 By mail to orders@isic-systems.com
Support:	Via homepage www.isic-systems.com under aftersales By mail to service@isic-systems.com During office-hours (Mo-Fr: CET 0800 - 1600) at +45 70 20 70 77
Service:	Before shipment for service Request Return Material Authorization number at homepage www.isic-systems.com under RMA By mail to service@isic-systems.com

21 Revision history

Rev A	June 2015	First release

22 Appendix A: Pixel policy

ISO 9241-307:2008 guidelines for LCD pixel defects

Introduction

TFT displays consist of a set number of pixels. Each pixel consists of 3 sub-pixels also called dots (one red, one blue and one green). Every sub-pixel is addressed by its own transistor. As a result, the manufacturing of glass substrate is very complex.

Due to the nature of this manufacturing process, occasional defects can occur. Pixel defects or failures cannot be fixed or repaired and may occur at any stage during the service life of the TFT display.

To regulate the acceptability of defects and protect the end user, ISIC A/S complies with the ISO 9241-307:2008 standard. This standard recommends how many defects are considered acceptable in a display, before it should be replaced within the terms of the warranty.

Monitor classification

ISO 9241-307:2008

Allowed defects per type per million pixels						
Defect classes	Pixel defects			Cluster defect		
	Type 1	Type 2	Type 3 total ($2 \times N_{3a} + N_{3b}$)	Type 1	Type 2	Type 3
Class: 0	0	0	0	0	0	0
Class: I	1	1	5	0	0	0
Class: II	2	2	10	0	0	1
Class: III	5	15	100	0	0	5

ISIC TFT monitors comply with ISO 9241-307:2008 Class II.

Special agreements about other classifications can be made between ISIC A/S and the customer.

Measurement method/monitoring conditions for pixel defects

In compliance with the ISO-9241-307:2008 standard, the following conditions are observed:

- Final check for pixel fault undertaken right after burn-in, i.e. with pre-heating of the display.
- Surrounding temperature $25^{\circ}\text{C} \pm 5^{\circ}\text{C}$
- Relative air humidity 40–70%

Pixel definition

Every pixel consists of three sub-pixels/dots (red, blue, green).

Every sub-pixel has its own transistor.

The three sub-pixels/dots must be considered as one unit.



Pixel

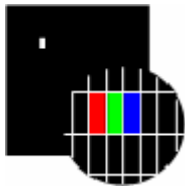

Pixel defect type 1 Pixel constantly lit

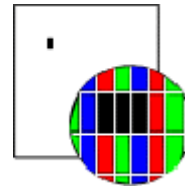

Pixel defect type 2 Pixel constantly dark

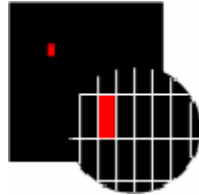

Pixel defect type 3a
Sub-pixel/dot (red, blue, green) constantly lit

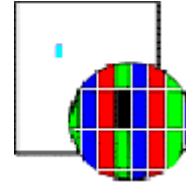

Pixel defect type 3b
Sub-pixel/dot (red, blue, green) constantly dark

Cluster

A cluster consists of 5 x 5 pixels.



Cluster pixel defect type 1
Pixels in a cluster area constantly lit

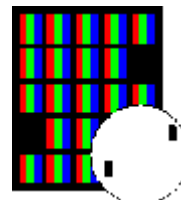

Cluster pixel defect type 2
Pixels in a cluster area constantly dark



Cluster pixel defect type 3a
Sub-pixels/dots in a cluster area constantly lit

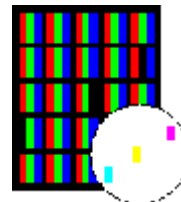

Cluster pixel defect type 3b
Sub-pixels/dots in a cluster area constantly dark

Pixel faults accepted by ISIC A/S

The maximum number of pixel faults that is considered acceptable at different screen resolutions is shown in the table below.

This is the native resolution and not the resolution as adjusted by user.

Class II

Allowable number of pixel faults in monitor applications							
Screen type	Native resolution	Number of pixels	Pixel defect type 1	Pixel defect type 2	Pixel defect Type 3 total ($2 \times N_{3a} + N_{3b}$)	Cluster defect type 1 and 2	Cluster defect type 3
WVGA	800x480	384,000	0	0	3	0	0
XGA	1024x768	768,432	1	1	7	0	0
WXGA	1280x800	1,024,000	2	2	10	0	1
SXGA	1280x1024	1,310,720	2	2	13	0	1
UXGA	1600x1200	1,920,000	3	3	19	0	1
FHD	1920x1080	2,073,600	4	4	20	0	2
WUXGA	1920x1200	2,304,000	4	4	23	0	2

23 Appendix B: Certificate of Conformity



EC DECLARATION OF CONFORMITY

We, manufacturer

ISIC A/S

Edwin Rahrs Vej 54, DK-8220 Brabrand, Denmark

hereby certifies that the

Products:

Category: Marine Panel Computer
Type: DuraPanel Glass
Models: 7", 12", 24" and 26"
ISIC Part Nos.: 06607-XXX and 06612-XXX
06624-XXX and 06626-XXX

are designed, manufactured and tested in Denmark, and complies with the requirements in the following directives and standards:

**2004/108/EC EMC Directive
IEC 60945:2002
IACS E10:2006**

Actual inspection/test data are on file and can be subject for examination.

22 June 2015

Edwin Rahrs Vej 54 DK-8220 Brabrand
Tel. +45 7020 7077
Fax +45 7020 7976

Bo Lander Rasmussen, CEO



Edwin Rahrs Vej 54
DK-8220 Brabrand
Denmark

Web: <http://www.isic-systems.com>

Email: service@isic-systems.com